

## Danville Community College Organizational Chart: President's Cabinet

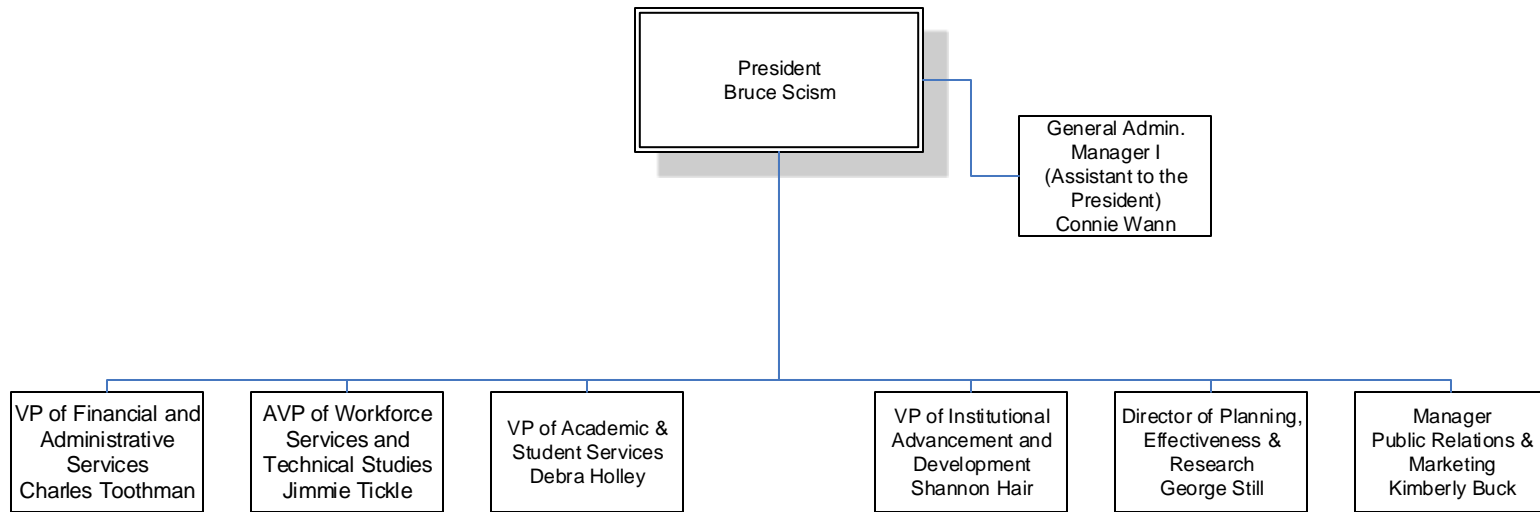

## Danville Community College Organizational Chart: Office of Financial and Administrative Services

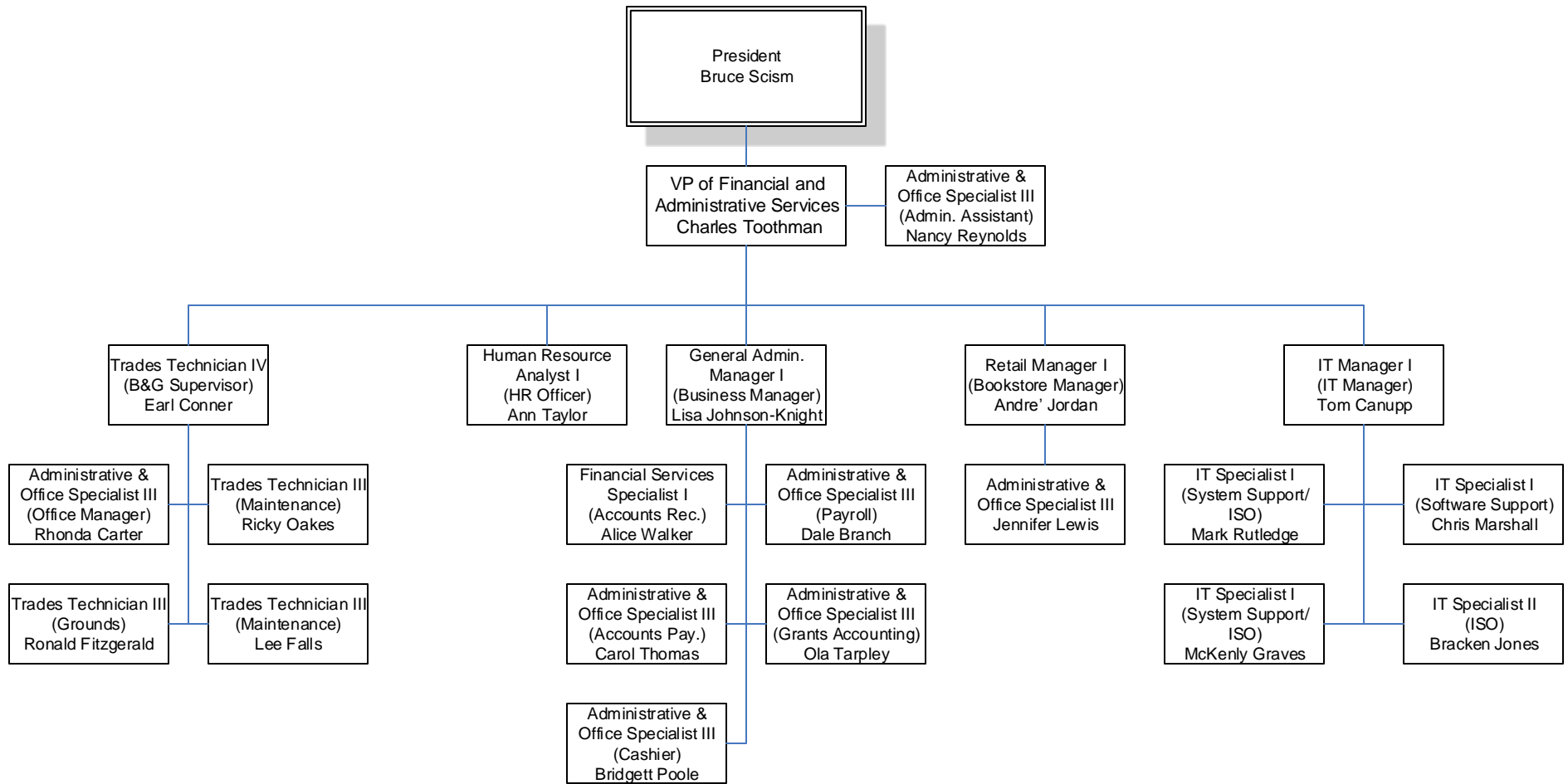

## Danville Community College Organizational Chart: Workforce Services & Technical Studies

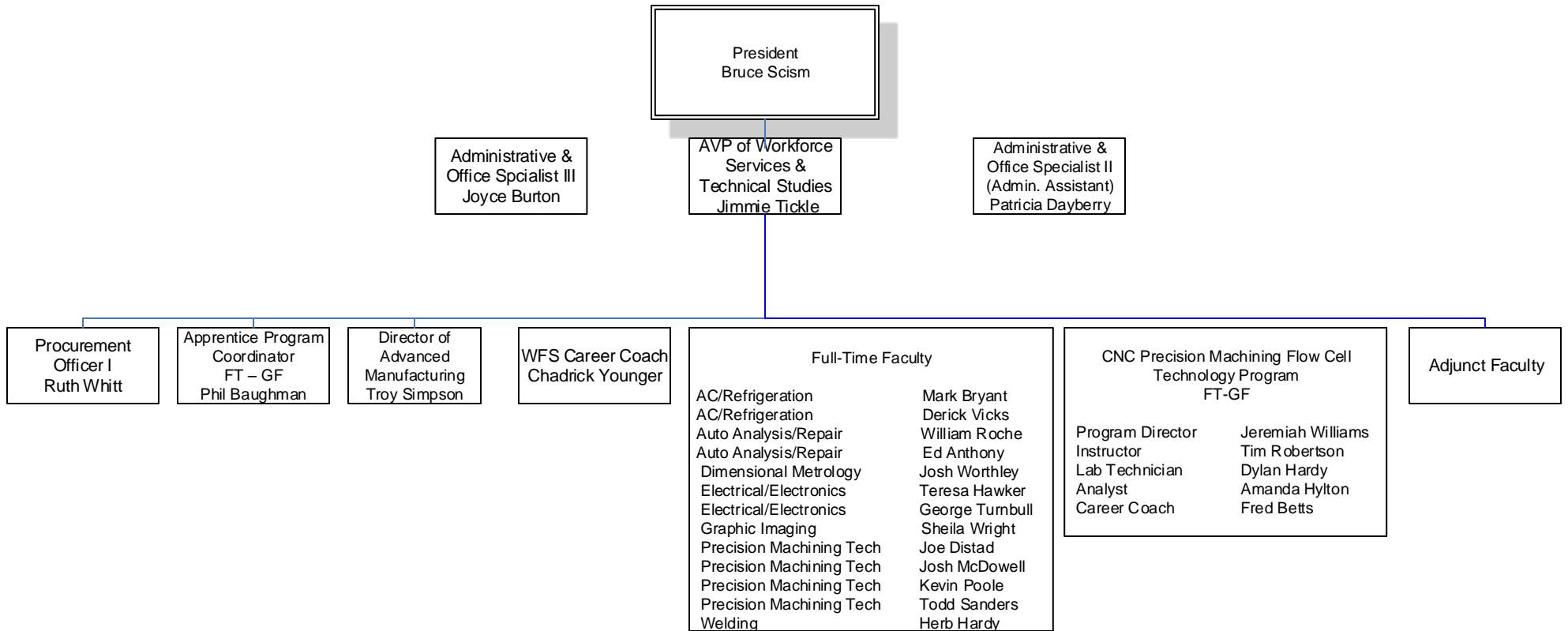

PT = Part-time  
 FT= Full-time  
 GF = Grant Funded

## Danville Community College Organizational Chart: Office of Academic and Student Services

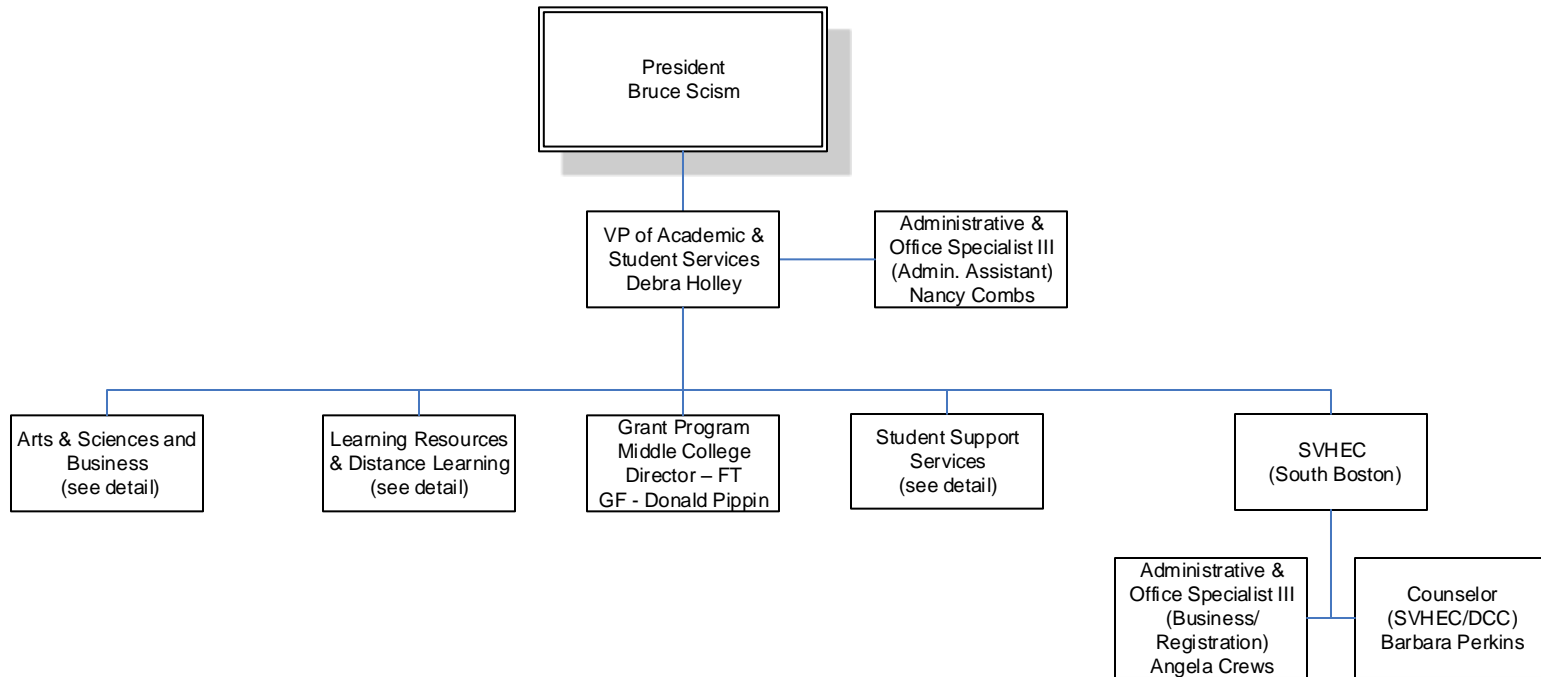

## Danville Community College Organizational Chart: Division of Arts & Sciences and Business

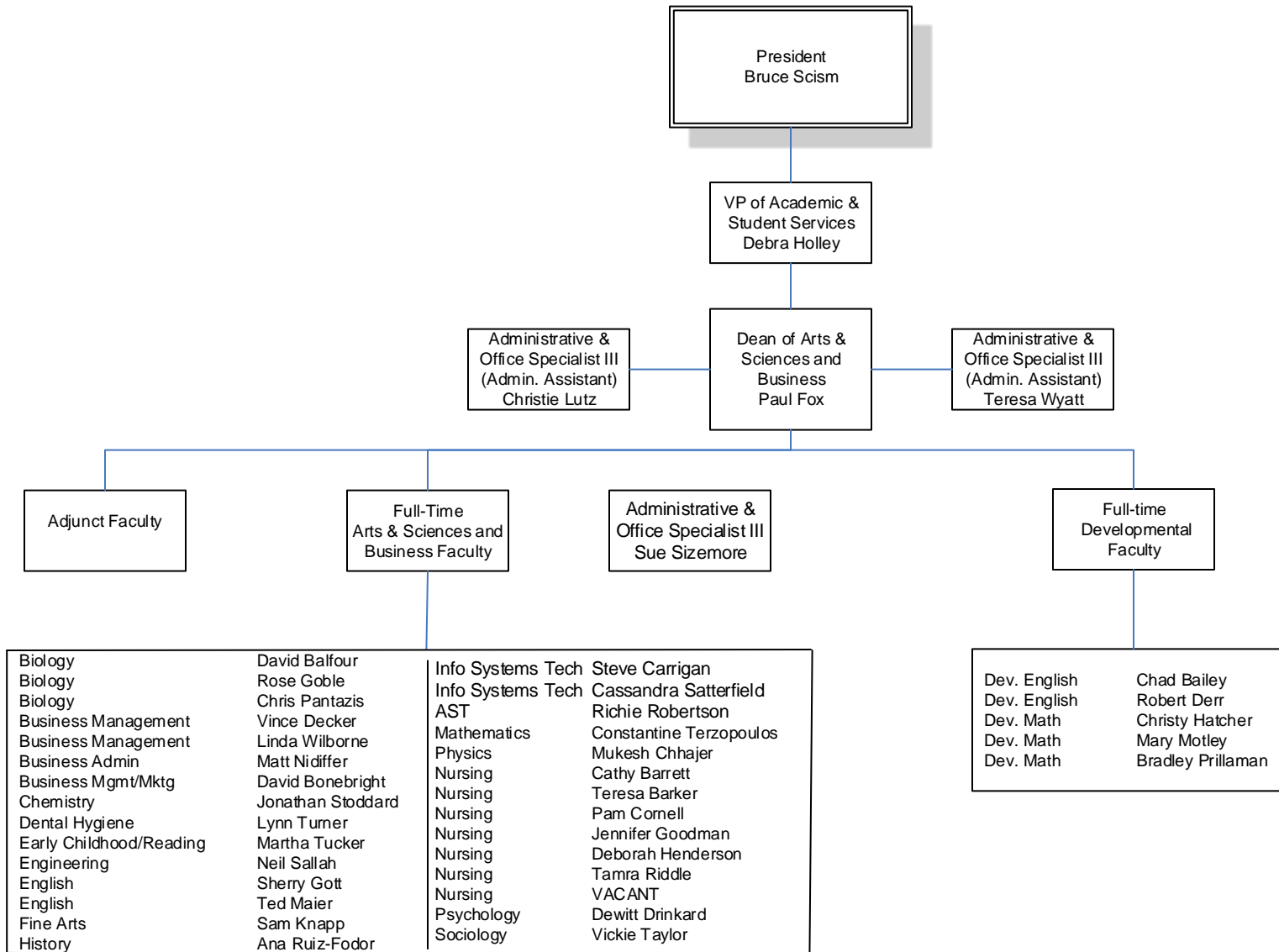

## Danville Community College Organizational Chart: Office of Learning Resources and Distance Learning

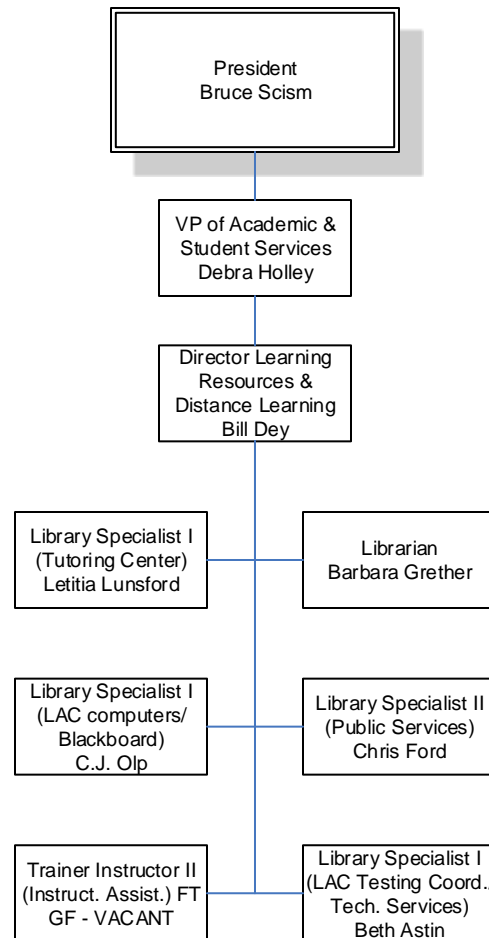

PT = Part-time  
 FT= Full-time  
 GF = Grant Funded

# Danville Community College Organizational Chart: Division of Student Support Services

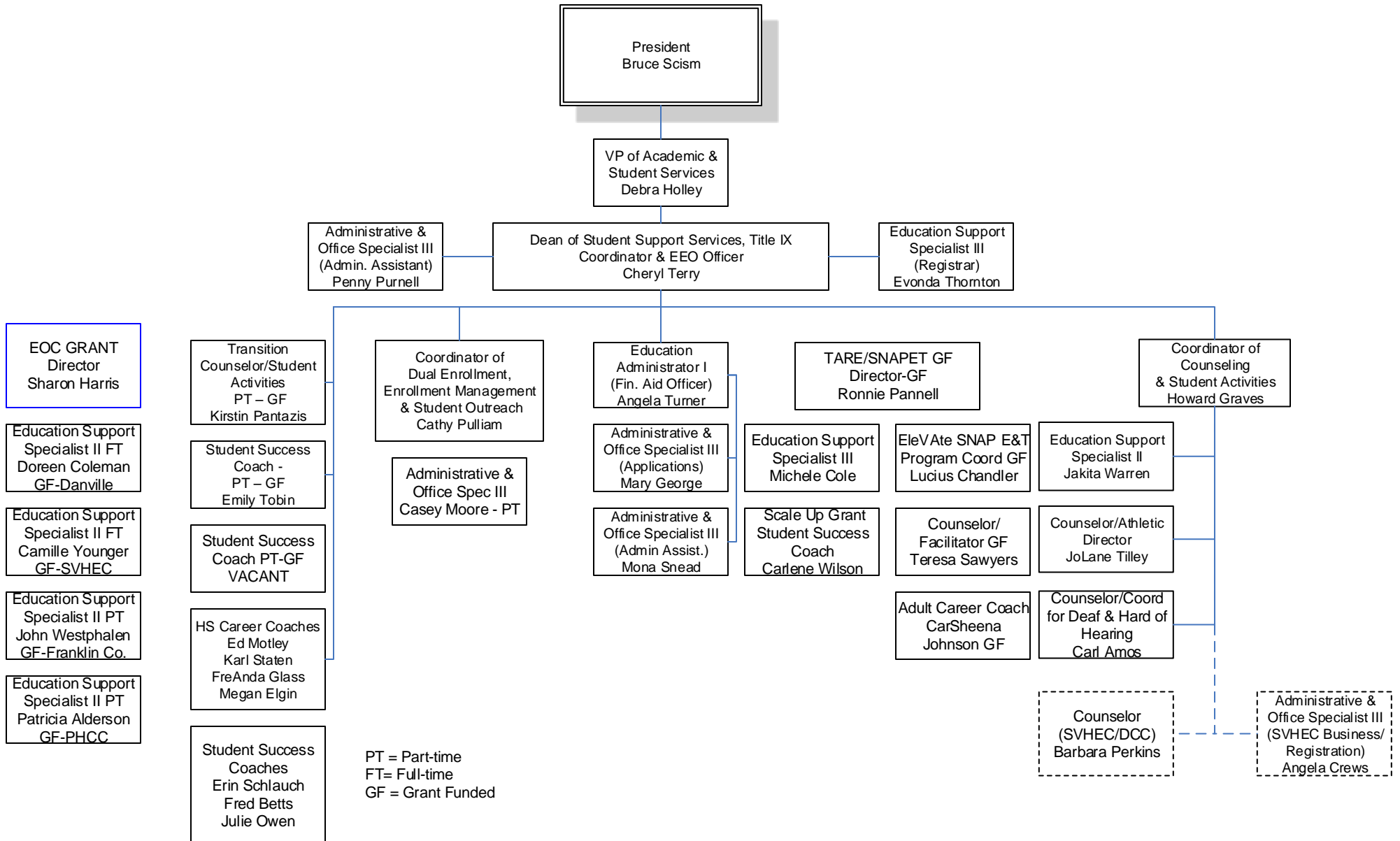

## Danville Community College Organizational Chart: Institutional Advancement and Development Office

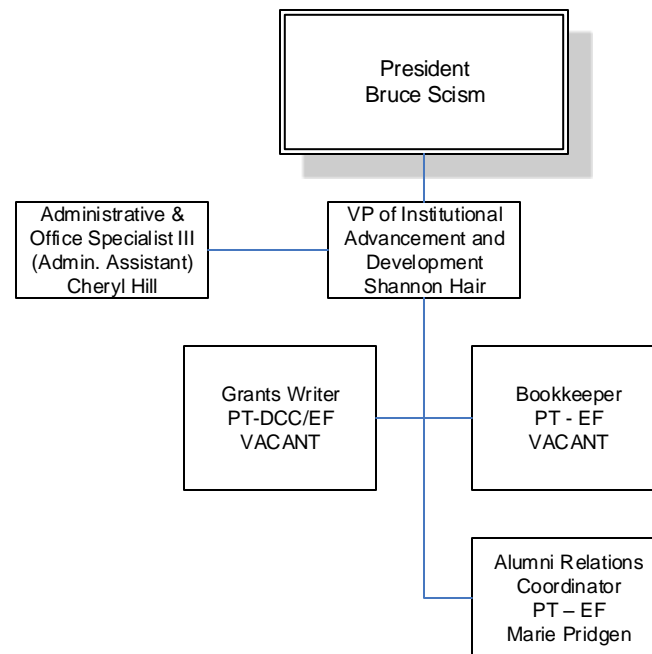

PT = Part-time  
FT= Full-time  
EF = Educational Foundation Funding  
DCC/EF = DCC/Educational Foundation Funding



## Danville Community College Organizational Chart: Office of Planning, Effectiveness & Research

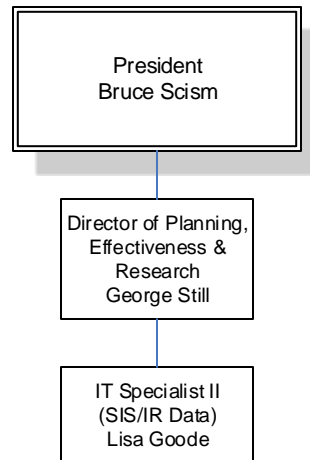

## Danville Community College Organizational Chart: Public Relations & Marketing

